



## INSTRUCTION MANUAL

VHF AIR BAND TRANSCEIVER

# IC-A220

A-7186D-1EX-2

- Certified TSO C128a and C169a
- This device complies with Part 15 of the FCC Rules. Operation is subject to the condition that this device does not cause harmful interference.

Icom America Inc.



---

Thank you for choosing this Icom product. This product is designed and built with Icom's state of the art technology and craftsmanship. With proper care, this product should provide you with years of trouble-free operation.

---

## IMPORTANT

---

**READ ALL INSTRUCTIONS** carefully and completely before using the transceiver.

**SAVE THIS INSTRUCTION MANUAL** — This instruction manual contains important operating instructions for the IC-A220.

---

## FCC INFORMATION

---

• **FOR CLASS A UNINTENTIONAL RADIATORS:**

This equipment has been tested and found to comply with the limits for a Class A digital device, pursuant to part 15 of the FCC Rules. These limits are designed to provide reasonable protection against harmful interference when the equipment is operated in a commercial environment. This equipment generates, uses, and can radiate radio frequency energy and, if not installed and used in accordance with the instruction manual, may cause harmful interference to radio communications. Operation of this equipment in a residential area is likely to cause harmful interference in which case the user will be required to correct the interference at his own expense.

• **POUR LES RAYONNEMENTS NON INTENTIONNELS DE CLASSE A:**

Cet équipement a été testé et reconnu conforme aux limites fixées pour un appareil numérique de classe A, conformément au point 15 de la réglementation FCC. Ces limites sont définies de façon à fournir une protection raisonnable contre le brouillage préjudiciable lorsque cet appareil est utilisé dans un environnement commercial. Cet équipement génère, utilise et peut émettre un rayonnement de fréquence radio. S'il n'a pas été installé conformément aux instructions, il peut par ailleurs créer des interférences perturbant les communications radio.

L'utilisation de cet appareil dans une zone résidentielle peut provoquer un brouillage préjudiciable, auquel cas l'utilisateur sera tenu de corriger la situation à ses frais.

**CAUTION:** Changes or modifications to this transceiver, not expressly approved by Icom Inc., could void your authority to operate this transceiver under FCC regulations.

---

## EXPLICIT DEFINITIONS

---

The explicit definitions below apply to this instruction manual.

WORD	DEFINITION
 <b>WARNING!</b>	Personal injury, fire hazard or electric shock may occur.
<b>CAUTION</b>	Equipment damage may occur.
<b>NOTE</b>	If disregarded, inconvenience only. No risk of personal injury, fire or electric shock.

---

## PRECAUTIONS

---

⚠ **WARNING! NEVER** operate the transceiver with a headset or other audio accessories at high volume levels. The continuous high volume operation may cause a ringing in your ears. If you experience the ringing, reduce the volume level or discontinue use.

⚠ **WARNING! NEVER** connect the transceiver to an AC outlet or to a power source of more than 28 V DC. Such a connection will damage the transceiver.

**CAUTION: NEVER** connect the transceiver to a power source that is DC fused at more than 10 A. Accidental reverse connection will be protected by this fuse, higher fuse values will not give any protection against such accidents and the transceiver will be damaged.

**DO NOT** operate the transceiver near unshielded electric blasting caps or in an explosive atmosphere.

**DO NOT** connect the transceiver to a power source using reverse polarity. This connection will not only blow fuses but also may damage the transceiver.

**DO NOT** place unit in a non-secure place to avoid inadvertent use by children.

**DO NOT** push the PTT when you do not actually intend to transmit.

**DO NOT** operate or place the transceiver in direct sunlight or in areas with temperatures below  $-20^{\circ}\text{C}$  ( $-4^{\circ}\text{F}$ ) or above  $+55^{\circ}\text{C}$  ( $+131^{\circ}\text{F}$ ).

**DO NOT** place the transceiver in excessively dusty environments.

**DO NOT** use harsh solvents such as benzine or alcohol to clean the transceiver, as they will damage the transceiver's surfaces. If the transceiver becomes dusty or dirty, wipe it clean with a soft, dry cloth.

**BE CAREFUL!** The transceiver will become hot when operating it continuously for long periods of time.

**CAUTION:** In Canada, use of 8.33 kHz Channel Spacing of this radio is strictly prohibited and shall not be used.

Icom is not responsible for the destruction or damage to the Icom transceiver, if the malfunction is because of:

- Force majeure, including, but not limited to, fires, earthquakes, storms, floods, lightning, other natural disasters, disturbances, riots, war, or radioactive contamination.
- The use of Icom transceivers with any equipment that is not manufactured or approved by Icom.

Icom, Icom Inc. and Icom logo are registered trademarks of Icom Incorporated (Japan) in Japan, the United States, the United Kingdom, Germany, France, Spain, Russia, Australia, New Zealand, and/or other countries.

---

## PRÉCAUTIONS

---

**⚠ NE JAMAIS** utiliser l'émetteur-récepteur avec un casque ou d'autres accessoires audio ayant un volume trop élevé. Un volume continu trop fort peut entraîner un bourdonnement dans vos oreilles. Si vous entendez une sonnerie baissez le niveau sonore ou interrompez l'utilisation.

**⚠ NE JAMAIS** relier l'émetteur-récepteur à une prise d'alimentation de plus de 28 V. Un tel branchement endommagerait votre émetteur-récepteur.

**NE JAMAIS** brancher l'émetteur-récepteur à une alimentation continue dont le fusible de protection excède 10 A. Ce fusible protège contre l'inversion accidentelle des branchements.

**NE PAS** utiliser l'émetteur-récepteur près d'amorces électriques non blindées ou en atmosphère explosive.

**NE JAMAIS** brancher le transceiver à une source d'alimentation employant la polarité inversée.

**NE PAS** appuyer sur la touche PTT lorsqu'on ne souhaite pas émettre.

**NE PAS** d'utiliser ou d'exposer l'émetteur-récepteur en plein soleil ou à une température ambiante inférieure à  $-20^{\circ}\text{C}$  ou supérieure à  $+55^{\circ}\text{C}$ .

**NE PAS** placer l'émetteur-récepteur dans des endroits excessivement poussiéreux.

**NE PAS** nettoyer l'appareil avec des solvants agressifs tels que benzène ou alcool, susceptibles d'endommager les surfaces exposées du boîtier. En cas de dépôt de poussière ou de salissures sur l'émetteur-récepteur, il faut l'essuyer avec chiffon doux et sec.

**ATTENTION!** Le transceiver devient chaud lors d'utilisations continues de longue durée. L'émetteur-récepteur chauffe en cas d'utilisation continue sur une longue durée.

L'antenne doit être placée à au moins un mètre de la position de chacune des personnes à bord de l'aéronef.

**MISE EN GARDE:** Utilisation de 8,33 kHz Espacement des canaux de cette radio est strictement interdite et ne doit pas être utilisé au Canada.

---

## SAFETY TRAINING INFORMATION

---



Your Icom radio generates RF electromagnetic energy during transmit mode. This radio is designed for and classified as “Occupational Use Only,” meaning it must be used only during the course of employment by individuals aware of the hazards, and the ways to minimize such hazards. This radio is **NOT** intended for use by the “General Population” in an uncontrolled environment.

- For compliance with FCC and Industry Canada RF Exposure Requirements, the transmitter antenna installation shall comply with the following two conditions:
  1. The transmitter antenna gain shall not exceed 0 dBi.
  2. The antenna is required to be located outside of a vehicle and kept at a distance of 50 centimeters or more between the transmitting antenna of this device and any persons during operation. For a small vehicle, the antenna as worst case, the antenna shall be located on the roof top at any place on the centre line along the vehicle in order to achieve 50 centimeters separation distance. In order to ensure this distance is met, the installation of the antenna must be mounted at least 50 centimeters away from the nearest edge of the vehicle in order to protect against exposure to bystanders.



To ensure that your exposure to RF electromagnetic energy is within the FCC allowable limits for occupational use, always adhere to the following guidelines:

- **DO NOT** operate the radio without a proper antenna attached, as this may damage the radio and may also cause you to exceed FCC RF exposure limits. A proper antenna is the antenna supplied with this radio by the manufacturer or an antenna specifically authorized by the manufacturer for use with this radio.
- **DO NOT** transmit for more than 50% of total radio use time (“50% duty cycle”). Transmitting more than 50% of the time can cause FCC RF exposure compliance requirements to be exceeded. The radio is transmitting when the “TX” indicator appears. You can cause the radio to transmit by pressing the PTT switch.

### **Electromagnetic Interference/Compatibility**

During transmissions, your Icom radio generates RF energy that can possibly cause interference with other devices or systems. To avoid such interference, turn off the radio in areas where signs are posted to do so. **DO NOT** operate the transmitter in areas that are sensitive to electromagnetic radiation such as hospitals, aircraft, and blasting sites.

---

## INFORMATION EN MATIÈRE DE SÉCURITÉ

---



AVERTISSEMENT

Votre radio Icom produit une énergie électromagnétique de radiofréquences (RF), en mode de transmission. Cette radio est conçue pour un «usage professionnel seulement» et classée comme tel, ce qui signifie qu'elle doit être utilisée uniquement dans le cadre d'un travail par des personnes conscientes des dangers et des mesures visant à minimiser ces dangers. Elle **N'EST PAS** conçue pour une «utilisation grand public», dans un environnement non contrôlé.

- Afin de satisfaire aux exigences de la FCC et d'Industrie Canada en matière d'exposition aux RF, il est nécessaire que l'antenne soit installée conformément aux deux conditions suivantes:

1. Le gain de l'antenne du radio émetteur ne doit pas dépasser 0 dBi.
2. Il faut que l'antenne émettrice de cet appareil soit placée à l'extérieur d'un véhicule et tenue éloignée d'au moins 50 centimètres de toute personne pendant le fonctionnement. Dans le pire des cas, pour un petit véhicule, l'antenne doit être placée sur le toit, n'importe où dans l'axe central du véhicule, afin de respecter une distance de 50 cm du bord le plus rapproché du véhicule et ainsi éviter que les personnes présentes soient exposées.



MISE EN GARDE

Afin de vous assurer que votre exposition à une énergie électromagnétique de RF se situe dans les limites permises par la FCC pour une utilisation grand public, veuillez en tout temps respecter les directives suivantes:

- **NE PAS** faire fonctionner la radio sans qu'une antenne appropriée y soit fixée, car ceci risque d'endommager la radio et causer une exposition supérieure aux limites établies par la FCC. L'antenne appropriée est celle qui est fournie avec cette radio par le fabricant ou une antenne spécialement autorisée par le fabricant pour être utilisée avec cette radio.
- **NE PAS** émettre pendant plus de 50% du temps total d'utilisation de l'appareil («50% du facteur d'utilisation»). Émettre pendant plus de 50% du temps total d'utilisation peut causer une exposition aux RF supérieure aux limites établies par la FCC. La radio est en train d'émettre lorsque le témoin du mode de transmission s'affiche sur l'écran ACL. La radio émettra si vous appuyez sur le bouton du microphone.

### Interférence électromagnétique et compatibilité

En mode de transmission, votre radio Icom produit de l'énergie de RF qui peut provoquer des interférences avec d'autres appareils ou systèmes. Pour éviter de telles interférences, mettez la radio hors tension dans les secteurs où une signalisation l'exige. **NE PAS** faire fonctionner l'émetteur dans des secteurs sensibles au rayonnement électromagnétique tels que les hôpitaux, les aéronefs et les sites de dynamitage.

---

# TABLE OF CONTENTS

---

IMPORTANT .....	i
FCC INFORMATION .....	i
EXPLICIT DEFINITIONS .....	i
PRECAUTIONS .....	ii
SAFETY TRAINING INFORMATION.....	iv
INFORMATION EN MATIÈRE DE SÉCURITÉ.....	v
<b>1 PANEL DESCRIPTION.....</b>	<b>1–3</b>
■ Front panel.....	1
■ Rear panel .....	2
■ Function display .....	3
<b>2 BASIC OPERATION.....</b>	<b>4–6</b>
■ General description .....	4
■ Receiving and transmitting.....	5
■ Directly setting the frequency.....	6
■ Squelch settings.....	6
<b>3 MEMORY OPERATION.....</b>	<b>7–12</b>
■ General description .....	7
■ Basic operation .....	8
■ Editing Regular memory/Group memory channels .....	8
■ Selecting a weather memory channel .....	12
■ History memory channel .....	12
■ Protecting memory.....	12
<b>4 OTHER FUNCTIONS .....</b>	<b>13–16</b>
■ Dualwatch operation .....	13
■ Priority watch .....	13
■ Accessing the 121.5 MHz emergency frequency.....	14
■ Enabling the intercom .....	14
■ Opening the squelch for test.....	14
■ Setting the frequency step .....	15
■ Using the remote control.....	15
■ Scanning the weather memory channels.....	15
■ Low voltage indicator .....	16
<b>5 MENU MODE.....</b>	<b>17–24</b>
■ Using the menu mode.....	17
■ Settings menu items .....	19
■ Configuration menu items .....	21
<b>6 SPECIFICATIONS .....</b>	<b>25</b>
<b>7 INFORMATION .....</b>	<b>26</b>
■ TSO Deviation list .....	26
■ VFO channel ID list.....	26
INDEX.....	27

# 1

## PANEL DESCRIPTION

### ■ Front panel

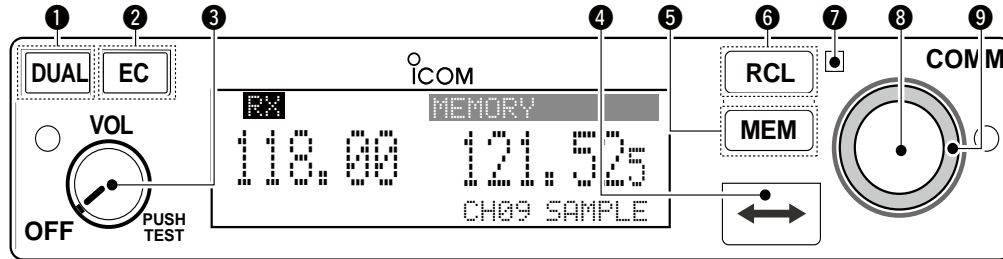

#### ① DUAL KEY [DUAL]

- Push to turn Dualwatch operation ON or OFF. (p. 13)
- Hold down for two seconds to turn the intercom function ON or OFF.

#### ② EMERGENCY CHANNEL KEY [EC]

- Push to set the emergency frequency (121.5 MHz) as the standby frequency. (p. 14)
- Hold down for two seconds to enter the direct frequency setting mode (p. 6), and set the emergency frequency (121.5 MHz). (p. 14)

#### ③ VOLUME/POWER SWITCH [VOL]

- Turn ON or OFF the transceiver.
- Adjusts the audio output level.  
The volume level bar is displayed while rotating [VOL].
- Hold down for two seconds to enter the AM squelch level "SQL LEVEL" item in the Settings menu. (p. 6)
- Push to turn ON or OFF the squelch test function. (p. 14)\*

\*When the squelch test function is ON, and the Auto squelch "AUTO SQL" item in the Configuration menu (p. 21) is set to "USER SET," push [VOL] again to change the squelch mode. (p. 6)

**CAUTION: DO NOT** turn ON power until the engines have been started. Otherwise, the power supply circuit may damage.



**4 FREQUENCY EXCHANGE (FLIP-FLOP) KEY [↔]**

- Push to exchange the standby frequency with the active frequency. (p. 5)
- Hold down for two seconds to enter the direct frequency setting mode. (p. 6)

**5 MEMORY KEY [MEM]**

Hold down for 2 seconds to enter the displayed frequency into any blank regular memory channel or clear or revive the selected memory channel (depending on the operating mode).

**6 RECALL KEY [RCL]**

- Push to enter or exit the memory mode. (p. 8)
- Hold down for two seconds to enter the Settings menu. (p. 17)
- Push to exit the Settings menu. (p. 17)

**7 LIGHT-SENSITIVE DETECTOR**

This detector senses ambient light. The detector is used to automatically adjust “DISP LOW” or “DISP HIGH” (pp. 22, 23) when the “DISP MODE” (p. 22) is set to ‘AUTO.’

**8 INNER (Small) TUNING DIAL [DIAL]**

- Rotate to set the standby frequency (kHz digit) (p. 5), or select a memory channel (p. 8), or menu mode setting. (pp. 17, 18)

**9 OUTER (Large) TUNING DIAL [O-DIAL]**

Rotate to set the standby frequency (MHz digit) (p. 5), select a group memory channel (p. 8), select the input digit for group name (p. 10), and so on.

**■ Rear panel**

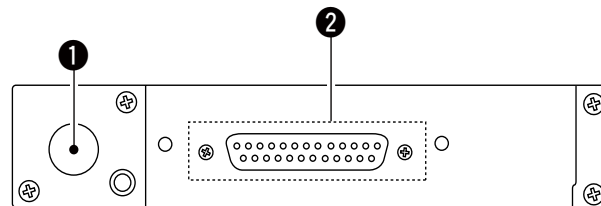

**1 ANTENNA CONNECTOR**

Connect the antenna connector.

**2 D-SUB 25 PIN CONNECTOR**

Connect a 13.8 V or 27.5 V DC power supply, speaker, and headset. Refer to ‘INSTALLATION GUIDE’ for details.

**NOTE:** If any external intercom system is in use, we recommend that you disable the transceiver’s intercom function to prevent degradation of the audio signal. If any degradation exists, leave pin 17 disconnected and disable the transceiver’s intercom function (p. 23).

# 1 PANEL DESCRIPTION

## ■ Function display

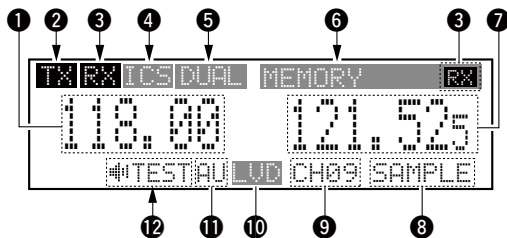

### 1 ACTIVE FREQUENCY READOUT

- Displays the active frequency. (p. 5)
- Displays the menu mode items in the menu mode. (p. 17)

### 2 TX INDICATOR

Displayed while transmitting. (p. 5)

### 3 RX INDICATOR

- Displayed when receiving a signal on the active frequency. (p. 5)
- Displayed when receiving a signal on the standby frequency during Dualwatch operation. (p. 13)
- Displayed when opening the active frequency's squelch function. (p. 5)

### 4 INTERCOM READOUT

Displays "ICS" when the intercom function is in use. (p. 14)

### 5 DUALWATCH READOUT

Displays "DUAL" when the Dualwatch function is ON. (p. 13)

### 6 MEMORY TYPE READOUT

- Displays "MEMORY" when the regular memory channel is selected. (p. 8)
- Displays "GRP01"-"GRP05" when the group memory channel is selected. (p. 8)  
The group name is also displayed if the name has been entered.
- Displays "HISTORY" when the history memory channel is selected. (p. 12)
- Displays "WEATHER" when the weather memory channel is selected. (p. 12)

### 7 STANDBY FREQUENCY READOUT

- Displays the standby frequency. (p. 5)
- Displays options in the menu mode. (p. 17)

### 8 CHANNEL NAME READOUT

Displays the channel name in the memory mode. (p. 10)

### 9 MEMORY CHANNEL READOUT

Displays the selected memory channel number in the memory mode. (p. 8)

### 10 LOW VOLTAGE INDICATOR

Displays "LVD" when the voltage is low. (p. 16)

### 11 SQUELCH MODE READOUT

Displays the squelch mode status. (pp. 6, 19)

### 12 TEST INDICATOR

Displays "#TEST" while the squelch test function is ON. (p. 14)

## ■ General description

The flow chart below shows the basic operating procedures. You need to set the frequency, activate the frequency, and receive or transmit.

There are two ways to set the frequency. See page 5 and 6 for details.

### • Set the frequency normally

Set the standby frequency.



Activate the frequency.



Receive/transmit

### • Set the frequency directly

Enter the direct frequency setting mode.



Set the operating frequency.



Receive/transmit

### Set the frequency normally

Set the frequency which will be used for the next operating frequency in the standby frequency display. Then exchange the active frequency for the standby frequency.

### Set the frequency directly

You can directly set the frequency. See 'Directly setting the frequency.'

**TIP:** For quick frequency setting, you can enter often-used frequencies into memory channels. See "MEMORY OPERATION" for details. (pp. 7–12)  
When you recall a memory channel, the previous standby frequency is overwritten.

## 2 BASIC OPERATION

### ■ Receiving and transmitting

#### 1. Setting the standby frequency

Rotate **[DIAL]** and **[O-DIAL]** to set the standby frequency.

- The active frequency is not affected.
- Rotate **[O-DIAL]** to set above 1 MHz digit.
- Rotate **[DIAL]** to set below 100 kHz digit.
- You can set the frequency step in the Settings menu. (p. 20)

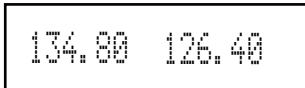

134.80 126.40

#### 2. Exchanging the frequency

After setting the standby frequency, push **[↔]** to exchange it with the active frequency.

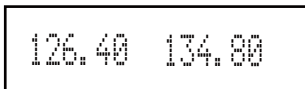

126.40 134.80

**NOTE: DO NOT** hold down **[↔]** continuously. Otherwise, the standby frequency disappears. In this case, hold down **[↔]** until the standby frequency appears again.

#### 3. Receiving

While receiving a signal, "RX" is displayed and audio is heard.

- Rotate **[VOL]** to adjust the audio level.
- Adjust the squelch if necessary. See 'Squelch settings' for details.

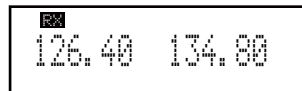

RX 126.40 134.80

#### 4. Transmitting

- ① Hold down PTT switch, and then speak at your normal voice level.
  - "TX" is displayed.
  - **DO NOT** hold the microphone too closely to your mouth or speak too loudly. This may distort your signal.

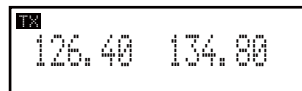

TX 126.40 134.80

- ② Release the PTT switch to receive.

**NOTE:** To prevent interference, listen on the frequency before transmitting. If the frequency is busy, wait until it is clear.

## ■ Directly setting the frequency

You can also directly set the frequency.

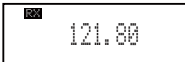
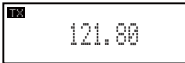
- ① Hold down [↔] for 2 seconds to enter the direct frequency setting mode.
  - Only the active frequency is displayed.
- ② Set an operating frequency.
  - Rotate [O-DIAL] to set above 1 MHz 
  - Rotate [DIAL] to set below 100 kHz digit.
  - You can set the frequency step in the Settings menu. (p. 20)
- ③ When a signal is received, "RX" is displayed and audio is heard.
  - Rotate [VOL] to adjust the audio level. 
  - Adjust the squelch if necessary. See 'Squelch settings' for details.
- ④ Hold down PTT switch, and then speak at your normal voice level.
  - "TX" is displayed. 
  - **DO NOT** hold the microphone too closely to your mouth or speak too loudly. This may distort your signal.
- ⑤ Release the PTT switch to receive.
- ⑥ Push [RCL] or [↔] to exit the direct frequency setting mode.

## ■ Squelch settings

### ◇ Adjusting the squelch

Adjust the squelch to mute the noise when no signal is received.

- ① Hold down [VOL] for two seconds to enter the AM squelch level setting menu.
  - "SQL LEVEL" is displayed.
- ② Rotate [DIAL] to select the squelch level to between -10 and 10.
- ③ Push [RCL] to exit AM squelch level setting menu.

### ◇ Changing the squelch mode

You can change the squelch mode when the Auto squelch "AUTO SQL" item in the Configuration menu (p. 21) is set to "USER SET."

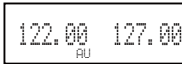
- ① Push [VOL] to turn ON the squelch test function.
  - "RX" and "TEST" are displayed. 
  - The squelch mode readout "MN" or "AU" blinks.
- ② Push [VOL] again while the squelch mode readout is blinking to change the squelch mode.
  - "RX" and "TEST" disappear and the squelch test function is turned OFF. 
  - MN (manual): Uses the squelch level set in "SQL LEVEL."
  - AU (auto): Prevents the audio from breaking up while receiving weak signals.
- ③ Repeat ①-② to change the squelch mode again.

## ■ General description

The transceiver has memory to store frequently used frequencies. You can easily set the frequency by selecting the channel from the memory.

The table below shows the structure of the memory mode. There are four memory channel types.

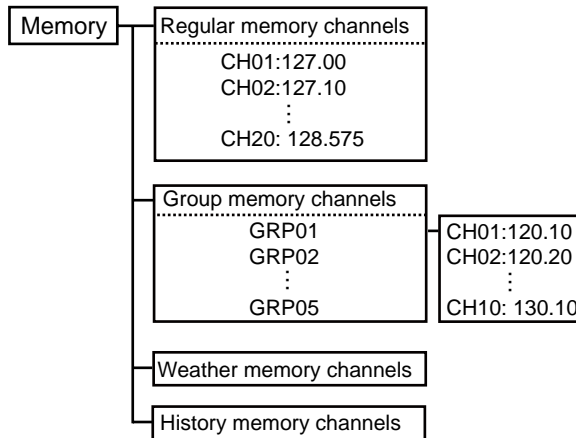

### ◇ Memory channel types

#### Regular memory channels (MEMORY)

Up to 20 memory channels can be selected.

#### Group memory channels (GRP01–GRP05)

There are up to 50 group channels, with 10 channels in each of 5 groups.

#### Weather memory channels (WEATHER)

10 weather memory channels can be selected.

These are used for monitoring NOAA (National Oceanic and Atmospheric Administration) broadcasts.

#### History memory channels (HISTORY)

Up to 20 history memory channels can be selected.

The active frequency is automatically written into history memory channels when you push [↔] to exchange the active and standby frequencies. (except weather memory channels.)

## ■ Basic operation

- ① Push **[RCL]** to enter the memory mode.

- The memory channel number is displayed.
- The memory channel name is also displayed if it has been entered.



- ② Rotate **[O-DIAL]** to select the memory channel types.

- For the group memory channel, push **[DIAL]** and then rotate **[O-DIAL]** to select a group.



- ③ Rotate **[DIAL]** to select a channel.



- ④ Push **[RCL]** to change standby frequency to the selected frequency and exit the memory mode.

- For the group memory channel, push **[RCL]** twice to change the standby frequency to the selected frequency and exit the memory channel.
- Hold down **[RCL]** for two seconds to exit the memory mode without changing the previously set standby frequency.

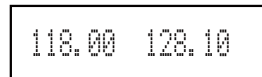

- ⑤ Push **[↔]** to exchange to the active frequency.

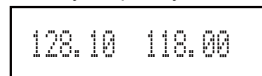

## ■ Editing Regular memory/Group memory channels

### ◇ Memory mode menu

There are memory mode menus to edit the memory contents. They contain the following items.

#### REPLACE (p. 9)

Enter the selected memory channel frequency to the standby frequency.

#### DELETE (p. 9)

Clears the selected memory channel contents.

#### REVIVE

Returns the selected memory channel to its previous state.

#### CH NAME (For only regular memory channel)

Sets the channel name to the selected regular memory channel.

#### GRP NAME (For only group memory channel)

Sets the group name to the selected memory group.

#### CH TAG (For only group memory channel)

Sets the channel tag to the selected memory channel. (Selecting the group memory channel is the only option.)

#### DONE

Returns to the memory mode.

### 3 MEMORY OPERATION

#### ◇ Enter frequencies into memory channels

To enter frequencies into memory channels, follow the steps below.

- ① Rotate **[DIAL]** and **[O-DIAL]** to set the standby frequency.
- ② Push **[RCL]** to enter the memory mode.
  - The memory channel number is displayed.
  - The memory channel name is also displayed if it has been entered.
- ③ Rotate **[O-DIAL]** to select a memory channel.
  - Select a regular memory channels or a group memory channels.
  - For the group memory channel, push **[DIAL]** and then rotate **[O-DIAL]** to select a group.
- ④ Push **[MEM]** and then rotate **[O-DIAL]** to select “REPLACE.”
  - The channel number blinks.
  - For the group memory channel, push **[DIAL]**, **[MEM]** and then rotate **[O-DIAL]** to select “REPLACE.”
- ⑤ Rotate **[DIAL]** to select a channel to be entered.
- ⑥ Push **[MEM]** to enter the frequency into the channel.
  - “WRITE COMPLETED” is displayed when the regular memory channel is entered.
- ⑦ Push **[RCL]** to exit the memory mode.



#### ◇ Clearing the memory contents

You can clear unwanted memory channels.

- ① Push **[RCL]** to enter the memory mode.
  - The memory channel number is displayed.
  - The memory channel name is also displayed if it has been entered.
- ② Rotate **[O-DIAL]** to select a memory channel.
  - Select a regular memory channel or a group memory channels.
  - For the group memory channel, push **[DIAL]** and then rotate **[O-DIAL]** to select a group.
- ③ Rotate **[DIAL]** to select a channel.
- ④ Push **[MEM]** and then rotate **[O-DIAL]** to select “DELETE.”
  - The channel number blinks.
  - For the group memory channel, push **[DIAL]**, **[MEM]** and then rotate **[O-DIAL]** to select “DELETE.”
- ⑤ Push **[MEM]** to clear the memory channel data.
- ⑥ Push **[RCL]** to exit the memory mode.





◇ Entering channel names

(For only regular memory channels)

The regular memory channels can display a six character name in addition to the memory number.

- ① Push **[RCL]** to enter the memory mode, and then rotate **[O-DIAL]** to select the regular memory channel.
- ② Rotate **[DIAL]** to select a channel.
- ③ Push **[MEM]** and then rotate **[O-DIAL]** to select “CH NAME.”
- ④ Push **[MEM]**.
  - The channel name’s 1st digit blinks.
- ⑤ Rotate **[DIAL]** to select a character.
  - Push **[DIAL]** to change from upper case letters (A, B, C, …) → lower case (a, b, c, …) → number (0, 1, 2, …) → then again to upper case letters (A, B, C, …) in sequential order.
  - You can enter the characters listed below.

A B C D E F G H I J K L M N O P Q R S T U V W X Y Z [\ ] ^ _ `
a b c d e f g h i j k l m n o p q r s t u v w x y z {   } ~ (space) ! " # \$ % & ' ( ) * + , - . /
0 1 2 3 4 5 6 7 8 9 : ; < = > ? @

- ⑥ Rotate **[O-DIAL]** to select the next input digit.
- ⑦ Repeat ⑤–⑥ to enter the memory channel name.
- ⑧ Push **[MEM]** to set the memory channel name.
- ⑨ Hold down **[RCL]**, or push **[RCL]** twice to exit the memory mode.

◇ Entering group names

(For only group memory channels)

The memory groups can display a six character name in addition to the group number (“GRP01”–“GRP05”).

- ① Push **[RCL]** to enter the memory mode, and then rotate **[O-DIAL]** to select the group memory channel.
- ② Push **[DIAL]** and then rotate **[O-DIAL]** to select a memory group from GRP01 to GRP05.
  - Push **[DIAL]** again to set the memory group.
- ③ Push **[MEM]** and then rotate **[O-DIAL]** to select “GRP NAME.”
- ④ Push **[MEM]**.
  - The group name’s 1st digit blinks.
- ⑤ Rotate **[DIAL]** to select a character.
  - Push **[DIAL]** to change from upper case letters (A, B, C, …) → lower case (a, b, c, …) → number (0, 1, 2, …) → then again to upper case letters (A, B, C, …) in sequential order.
  - You can enter the characters listed below.

A B C D E F G H I J K L M N O P Q R S T U V W X Y Z [\ ] ^ _ `
a b c d e f g h i j k l m n o p q r s t u v w x y z {   } ~ (space) ! " # \$ % & ' ( ) * + , - . /
0 1 2 3 4 5 6 7 8 9 : ; < = > ? @

- ⑥ Rotate **[O-DIAL]** to select the next input digit.
- ⑦ Repeat ⑤–⑥ to input the group name.
- ⑧ Push **[MEM]** to set the group name.
- ⑨ Hold down **[RCL]**, or push **[RCL]** twice to exit the memory mode.

### 3 MEMORY OPERATION

#### ◇ Selecting channel tag names

(For only group memory channels)

The tag name can be set to a three character name, in addition to the group number. It is convenient for separating memory types.

- ① Push **[RCL]** to enter the memory mode, and then rotate **[O-DIAL]** to select group memory channel.
- ② Push **[DIAL]** and then rotate **[O-DIAL]** to select a memory group from GRP01 to GRP05.
  - Push **[DIAL]** again to set the memory group.
- ③ Push **[MEM]** and then rotate **[O-DIAL]** to select “CH TAG.”
- ④ Push **[MEM]** and then rotate **[DIAL]** to select a channel tag.
  - The tag name shown to the right is selectable.
- ⑤ Push **[MEM]** to set the channel tag.
- ⑥ Hold down **[RCL]**, or push **[RCL]** twice to exit the memory mode.



#### Channel tag list

TAG NAME	DISPLAY	MEANS
	Group*1	
---	YES	Non-tag
TWR	YES	Tower
GND	YES	Ground
ATS	YES	ATIS
ATF	YES	Air traffic
APP	YES	Approach
ARR	YES	Arrival
AWS	YES	Automatic Weather Station
CLR	YES	Clearance / Delivery
CTF	YES	Common Traffic Advisory Frequency
DEP	YES	Departure
FSS	YES	Flight Service Station
RFS	YES	Remote Flight Service Station
UNI	YES	Unicom frequency
MF	YES	Mandatory frequency
OTH	YES	Other
U-1	YES	User1 setting (p. 23)
U-2	YES	User2 setting (p. 23)

\*1Group memory

#### About U-1/U-2

You can edit tag names of U-1 and U-2 in the Configuration menu. See page 23 for details.

## ■ Selecting a weather memory channel

- ① Push **[RCL]** to enter the memory mode.
- ② Rotate **[O-DIAL]** to select “WEATHER.”
- ③ Rotate **[DIAL]** to set a weather memory channel.
- ④ Push **[RCL]** to exit the memory mode.



### • Weather memory channel list

Channel	Frequency	Channel	Frequency
WX01	162.550 MHz	WX06	162.500 MHz
WX02	162.400 MHz	WX07	162.525 MHz
WX03	162.475 MHz	WX08	161.650 MHz
WX04	162.425 MHz	WX09	161.775 MHz
WX05	162.450 MHz	WX10	163.275 MHz

## ■ History memory channel

The transceiver has 20 history memory channels. When pushing **[↔]**, the active frequency is stored into a history memory channel.

The frequencies are stored into the history memory channel from “CH01” to “CH20.”

- ① Push **[RCL]** to enter the memory mode.
- ② Rotate **[O-DIAL]** to select “HISTORY.”
- ③ Rotate **[DIAL]** to set a history memory channel.
- ④ Push **[RCL]** to exit the memory mode.



## ■ Protecting memory

The transceiver has memory protection which inhibits the editing (storing, deleting, replacing, and so on) of the regular memory and group memory.

See ‘Memory Protection’ (p. 21) for details.

## ■ Dualwatch operation

The Dualwatch operation alternately monitors the active frequency and standby frequency at certain intervals, while no signal is detected on either frequency.

If a signal is detected on the active frequency, the transceiver changes to the active frequency and ignores the standby frequency until the signal disappears. On the other hand, if the valid signal is detected on the standby frequency, the transceiver changes to the standby frequency and ignores the active frequency.

- ① Push **[DUAL]** to enter Dualwatch operation.
  - “DUAL” is displayed above the active frequency.
  - When a signal is received, “RX” is displayed on the active or standby frequency. The transceiver ignores the other frequency.



- ② Push **[DUAL]** again to exit Dualwatch operation.
  - “DUAL” disappears.

## ■ Priority watch

If a signal is detected on the standby frequency while Dualwatch operation with the Priority watch is enabled (p. 21), the transceiver changes to the standby frequency and monitors the active frequency at the same time.

- ① Push **[DUAL]** to enter Dualwatch operation.
  - “DUAL” is displayed above the active frequency.
  - When receiving a signal on the standby frequency, the standby frequency’s “RX” blinks. However, the transceiver continues to monitor the active frequency.



- When receiving a signal on the active frequency, the active frequency’s “RX” is displayed. The transceiver ignores the standby frequency while receiving a signal on the active frequency.

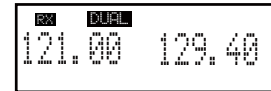

- ② Push **[DUAL]** again to exit Dualwatch operation.
  - “DUAL” disappears.

**ATTENTION!** While Dualwatch operation with the Priority watch is enabled, the standby frequency’s audio may be interrupted during the monitoring interval, but this is not a malfunction.

## ■ Accessing the 121.5 MHz emergency frequency

The transceiver can be set to the 121.5 MHz emergency frequency immediately.

- ① Hold down **[EC]** for two seconds to set the emergency frequency (121.50 MHz) in the direct frequency setting mode.

- “EC” is displayed.



- ② Hold down **[↔]** to return to the normal frequency display mode, and then push **[↔]** to exchange emergency frequency with the standby frequency.
  - Set the frequency other than 121.500 MHz before pushing **[↔]** to the standby frequency if necessary.
  - “EC” disappears.

You can also set the 121.5 MHz emergency frequency in the normal frequency display mode.

- ① Push **[EC]** to set the emergency frequency to the standby frequency.
- ② Push **[↔]** to change to the active frequency.
  - “EC” is displayed.

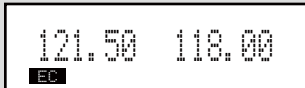

## ■ Enabling the intercom

When two headsets are connected to the transceiver, you can use them as a voice-activated intercom.

- ① While holding down **[DUAL]**, rotate **[VOL]** to turn ON the transceiver power.
  - The Configuration menu is displayed.
- ② Rotate **[O-DIAL]** to select “INCOM MODE.”
- ③ Rotate **[DIAL]** to select “ON.”
- ④ Push **[RCL]** to exit the Configuration menu.
  - The transceiver restarts.
- ⑤ Hold down **[DUAL]** for two seconds to enable the intercom function.
  - “ICS” is displayed.
  - You can set the headphones output level in the Settings menu. (p. 19)
  - You can also set microphone 1 and microphone 2 input audio levels in the Settings menu. (p. 19)

## ■ Opening the squelch for test

This function manually opens the squelch for testing.

- ① Push **[VOL]** to turn ON the squelch test function.
  - “RX” and “TEST” are displayed.
- ② To turn the function OFF, push **[VOL]** again.
  - “RX” and “TEST” disappear.

## 4 OTHER FUNCTIONS

### ■ Setting the frequency step

You can select Frequency steps of 8.33 kHz or 25 kHz in the menu mode.

- ① Hold down **[RCL]** for two seconds to enter the Settings menu.
- ② Rotate **[O-DIAL]** to select "FREQ. STEP."
- ③ Rotate **[DIAL]** to select the frequency steps of 8.33 kHz or 25 kHz.
- ④ Push **[RCL]** to exit the Settings menu.

**CAUTION:** In Canada, use of 8.33 kHz Channel Spacing of this radio is strictly prohibited and shall not be used .

### ■ Using the remote control

You can remotely control the frequency exchange key, intercom, and recall key by connecting pins 1, 3, and 17 of the D-Sub 25 pin connector on the rear panel to the switches connected to the power ground.

Refer to "INSTALLATION GUIDE" for details.

- Set the "REM SWAP," "REM INCOM," and "REM RECALL" item to ON in the Configuration menu. See page 24 for details.

### ■ Scanning the weather memory channels

Scanning automatically searches for weather channel signals.

Repeatedly scans all weather memory channels.

You can set the interval time (scan speed) for the scan in the Settings menu ("DW INTERVAL"). See page 21 for details.

- ① Push **[RCL]** to enter the memory mode, and then rotate **[O-DIAL]** to select the weather memory channel.
- ② Hold down **[VOL]** for two seconds to start a weather memory channel scan.
  - "SEARCH" blinks while scanning.
  - To change the scan direction, turn **[DIAL]**.
  - The scan continues even while receiving a signal on the active frequency.



- ③ While receiving a signal on the weather channel:
- “RX” blinks on the standby frequency display and the scan is cancelled.
  - “DUAL” is displayed on the active frequency display.



- ④ When no signal is received on any weather channels:
- “NO WTH” is displayed and the scan is canceled after “WX01” to “WX10” have been scanned 3 times and no signal is received.
- ⑤ Hold down **[VOL]** for two seconds to cancel the scan manually.

## ■ Low voltage indicator

You can transmit and receive, but we recommend that you check the power supply system for the cause of the low voltage.



## ■ Using the menu mode

You can customize the transceiver settings to suit your preferences and operating style.

There are two types of menu mode, Settings menu and Configuration menu.

### ◇ Using the Settings menu

- ① Rotate **[VOL]** to turn ON the transceiver's power.
  - Push **[RCL]** to exit the memory mode if necessary.
- ② Hold down **[RCL]** for two seconds to enter the Settings menu.
- ③ Rotate **[O-DIAL]** to select a setting item.
- ④ Rotate **[DIAL]** to select an option.
- ⑤ Push **[RCL]** to exit the Settings menu.

Settings menu items



← Item number  
← Setting value

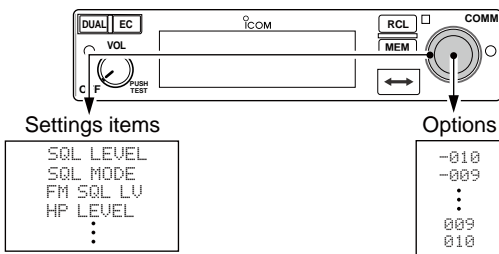

### • Settings menu items

Item	Ref.	Item	Ref.
SQL LEVEL	p. 19	MIC2 GAIN	p. 20
SQL MODE	p. 19	SIDETONE LV	p. 20
FM SQL LV	p. 19	DISP MAN	p. 20
HP LEVEL	p. 19	FREQ DISP	p. 20
INCOM LV1	p. 19	AUX LEVEL	p. 20
INCOM LV2	p. 19	BEEP	p. 20
ANL	p. 19	FREQ STEP	p. 20
MIC1 GAIN	p. 20		



◆ Using the Configuration menu

- ① While holding down [DUAL], rotate [VOL] to turn ON the transceiver's power.
  - Configuration menu is displayed.
- ② Rotate [O-DIAL] to select a setting item.
- ③ Rotate [DIAL] to select an option.
- ④ Push [RCL] to exit the Configuration menu and restart the transceiver.

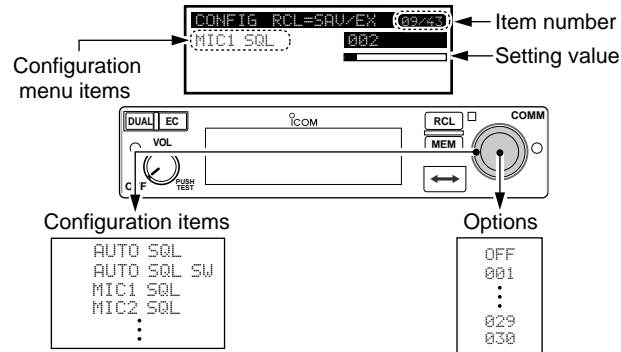

• Configuration menu items

Item	Ref.	Item	Ref.
AUTO SQL	p. 21	DISP HIGH	p. 23
AUTO SQL SW	p. 21	DISP RESP	p. 23
MIC1 SQL	p. 21	U-1 ID SET	p. 23
MIC2 SQL	p. 21	U-2 ID SET	p. 23
DW INTERVAL	p. 21	AUX IN	p. 23
PRI WATCH	p. 21	AUX MAX LVL	p. 23
PW INTERVAL	p. 21	INCOM MODE	p. 23
MEM PROTECT	p. 21	TIME OUT	p. 24
GRP MEMORY	p. 22	INTERLOCK	p. 24
TX MIC SEL	p. 22	INTLCK MODE	p. 24
DISP MODE	p. 22	REM SWAP	p. 24
DISP AUTO	p. 22	REM INCOM	p. 24
DISP EXT	p. 22	REM RECALL	p. 24
DISP LOW	p. 22	MEM CLEAR	p. 24

### ■ Settings menu items

#### ◇ **AM squelch level** “SQL LEVEL”

Adjusts the squelch level for the AM mode operation.

In order to receive signals properly, the squelch must be adjusted to the proper level.

- -010 to 010: Sets the AM squelch level to between -10 and 10.

#### ◇ **Squelch mode** “SQL MODE”

Sets the squelch mode for the AM mode operation.

- MANUAL: Use “SQL LEVEL” to set the squelch level.
- AUTO: Prevents the audio from breaking up while receiving weak signals.

#### ◇ **FM squelch level** “FM SQL LV”

Sets the squelch level for FM mode operation.

- -010 to 010: Sets the FM squelch level to between -10 and 10.

#### ◇ **Headphones level** “HP LEVEL”

Sets the headphones output level while receiving.

- AF GAIN: The output level is adjusted by **[VOL]**.
- OFF (0): Mutes the headphones.
- 001 to 080: Sets the audio level to between 1 and 80.

#### ◇ **Intercom 1 microphone audio input level** “INCOM LV1”

Sets the intercom 1 microphone input level.

- OFF (0): Mutes the intercom 1 microphone.
- 001 to 080: Sets the intercom 1 input level to between 1 and 80.

#### ◇ **Intercom 2 microphone audio Input level** “INCOM LV2”

Sets the intercom 2 microphone input level.

- OFF (0): Mutes the intercom 2 microphone.
- 001 to 080: Sets the intercom 2 input level to between 1 and 80.

#### ◇ **Automatic noise limiter** “ANL”

The ANL (Automatic Noise Limiter) function reduces noise components while receiving, such as those caused by the engine ignition systems.

- OFF: ANL function is OFF.
- ON: ANL function is ON.

**◇ Setting microphone 1 Gain “MIC1 GAIN”**

Sets microphone 1's gain.

- -010 to 010: Sets the microphone 1's gain to between -10 and 10.

**◇ Setting microphone 2 Gain “MIC2 GAIN”**

Sets microphone 2's gain.

- -010 to 010: Sets the microphone 2's gain to between -10 and 10.

**◇ Sidetone level “SIDETONE LV”**

When using an optional headset (user supplied) through an adapter, the transceiver sends your transmitted voice to the headset for monitoring.

\*Ask your dealer in details.

- OFF (0): The sidetone function is OFF.
- 001 to 080: Sets the sidetone level to between 1 and 80.

**◇ Manual dimmer control “DISP MAN”**

Sets the brightness manually to suit your own preferences.

- OFF: The display brightness is set to the minimum. The key backlight is OFF.
- 001 to 100: Sets the dimmer level to between 1 and 100.

**◇ Frequency display “FREQ DISP”**

Sets the 1 kHz digit frequency displaying on the OLED.

- OFF : The 1 kHz digit is not displayed on the OLED.
- ON : The 1 kHz digit is always displayed on the OLED.
- ZERO SUPP.: The 1 kHz digit is displayed only when the 1 kHz digit frequency is 5 kHz.

**◇ External input level “AUX LEVEL”**

Sets the external input level.

- OFF (0): The external input is disabled.
- 001 to 080: Sets the external input level to between 1 and 80.
- AF GAIN: Interlocked with [VOL].

**◇ Beep tone level “BEEP”**

Confirmation beep tones normally sound when storing memory, operating the time-out-timer function, and so on.

- OFF (0): The beep tone is OFF.
- 001 to 100: Sets the beep tone level to between 1 and 100.

**NOTE:** When using an external speaker and the squelch is closed, the beep tone level is fixed and cannot be changed in the Settings menu.

**◇ Frequency step “FREQ. STEP”**

Selects the frequency step: 8.33 kHz or 25 kHz.

- 25kHz: Sets the frequency step is set to 25 kHz.
- 8.33kHz: Sets the frequency step is set to 8.33 kHz.

**CAUTION:** In Canada, use of 8.33 kHz Channel Spacing of this radio is strictly prohibited and shall not be used.

### ■ Configuration menu items

#### ◇ Auto squelch “AUTO SQL”

Sets the Auto squelch function.

- OFF: The Auto squelch is OFF.
- ON: The Auto squelch is ON.
- USER SET: Sets the auto squelch in the Squelch mode “SQL MODE” item in the Settings menu. (p.19)

#### ◇ Squelch mode switch setting “AUTO SQL SW”

Sets the length of time that the squelch mode readout (p. 3) blinks when you change the squelch mode. (p. 6)

- 002 to 010: Sets the length of time that the squelch mode readout blinks to between 2 seconds and 10 seconds.

#### ◇ Intercom 1 squelch level “MIC1 SQL”

Sets Intercom 1’s squelch level.

The setting level is required to open the squelch when speaking into Intercom 1.

- OFF (0): Turns off Intercom 1’s squelch.
- 001 to 030: Sets Intercom 1’s squelch level to between 1 and 30.

#### ◇ Intercom 2 squelch level “MIC2 SQL”

Sets Intercom 2’s squelch level.

The setting level is required to open the squelch when speaking into Intercom 2.

- OFF (0): Turns off Intercom 2’s squelch.
- 001 to 030: Sets Intercom 2’s squelch level to between 1 and 30.

#### ◇ Dualwatch interval “DW INTERVAL”

Sets the interval time during Dualwatch or weather scan.

- FAST: The interval is set to 300 milliseconds.
- MID: The interval is set to 600 milliseconds.
- SLOW: The interval is set to 2 seconds.

#### ◇ Priority watch “PRI WATCH”

Sets the priority watch is enabled or not.

- ON: The priority watch is ON.
- OFF: The priority watch is OFF.

#### ◇ Priority watch interval “PW INTERVAL”

Sets the active frequency receive interval time while receiving the standby frequency.

- FAST: The interval is set to 400 milliseconds.
- MID: The interval is set to 800 milliseconds.
- SLOW: The interval is set to 2 seconds.

#### ◇ Memory protection “MEM PROTECT”

Sets the memory protection to regular memory channels and group memory channels.

Editing the regular memory and group memory channels is inhibited while the protection is ON.

- OFF: The memory protection is OFF.
- ON: The memory protection is ON.

### ◇ Group memory channel display “GRP MEMORY”

Selects whether the label is displayed or not.

- CH: Only the memory channel number is displayed.
- LABEL: The label is also displayed.

### ◇ Transmitting microphone selection “TX MIC SEL”

Selects the active microphone when pushing microphone's PTT switch.

This setting allows you to control which connected microphone is permitted to transmit.

- MIC1: Selects microphone 1.
- MIC2: Selects microphone 2.
- MIC1+2: Selects both microphone 1 and microphone 2.

### ◇ Dimmer mode “DISP MODE”

The dimmer function dims function display and key illumination brightness. You can select a dimmer functioning mode to suit your preference.

- OFF: The dimmer function is OFF.
- AUTO: Automatically sets the dimmer according to the current lighting condition.
- MANUAL: Manually sets the dimmer in the Manual dimmer control “DISP MAN” item. (p. 20)

### ◇ Dimmer auto mode “DISP AUTO”

Sets the method to automatically control the dimmer brightness.

- PHOTO: Controls the dimmer brightness by using the light sensitive detector. (p. 2)
- EXT: Controls the dimmer brightness by using an external voltage.

### ◇ External dimmer control “DISP EXT”

Sets the maximum voltage for the external voltage dimmer control.

- 14VDC: The maximum external voltage is 14 V DC.
- 28VDC: The maximum external voltage is 28 V DC.

### ◇ Dimmer brightness (Low) “DISP LOW”

Sets the minimum brightness level in the automatic adjustment range.

- OFF: Turn OFF the minimum dimmer brightness setting.
- 001 to 049: Sets the minimum dimmer brightness level to between 1 and 49.

### ◇ Dimmer brightness (High) “DISP HIGH”

Sets the maximum brightness level in the automatic adjustment range.

- 050 to 100: Sets the maximum dimmer brightness level to between 50 and 100.

### ◇ Dimmer response “DISP RESP.”

Sets the dimmer response speed when selecting “AUTO” in the Dimmer mode “DISP MODE” item. (p. 22)

- STANDARD: Selects the normal response speed.
- FAST: Selects the fast response speed.

### ◇ USER-1 setting/USER-2 setting

“U-1 ID SET”/“U-2 ID SET”

You can edit tag names of U-1 and U-2 channel tags (p.11).

- ① Push **[MEM]** to enter the U-1 or U-2 tag edit mode.
- ② Rotate **[DIAL]** to select a character.
- ③ Rotate **[O-DIAL]** to select the next input digit.
- ④ Repeat the steps ②–③ to input the tag name.
  - You can set 3 characters for the tag name.
- ⑤ Push **[MEM]** again to store the name, and exit the edit mode.

### ◇ External input “AUX IN”

Sets the audio usage input from an external audio device. Refer to ‘INSTALLATION GUIDE’ for the connection.

- OFF: The external audio is not used.
- ON: The external audio is output from the connected headset while no signal is received.
- INCOM: The external audio is output from the intercom 2’s headset when:
  - The intercom function is OFF.
  - While the intercom function is not in use.
  - While an audio signal is not input into the intercom 1’s microphone.

### ◇ External input gain “AUX MAX LVL”

Sets the maximum gain for audio usage input.

- 0 dB: The maximum gain for audio usage input is 0 dB.
- +3 dB: The maximum gain for audio usage input is +3 dB.
- +6 dB: The maximum gain for audio usage input is +6 dB.

### ◇ Intercom usable setting “INCOM MODE”

Sets the intercom using or not.

- ON: The intercom is usable.
- OFF: The intercom is unusable.

### ◇ Time-Out-Timer “TIME OUT”

To prevent accidental prolonged transmission, the transceiver has a time-out-timer. The function inhibits continuous transmissions longer than the set period of time.

- 005 to 035: Sets the time-out-timer period to between 5 seconds and 35 seconds in 1 second step.

### ◇ Interlock “INTERLOCK”

If the transceiver is connected together with the other transceiver, the interlock function can prevent the transceiver from receiving or transmitting while the other transceiver is transmitting.

- ON: The interlock function is ON.
- OFF: The interlock function is OFF.

### ◇ Interlock mode “INTLOCK MODE”

Sets the function to be disabled by the interlock.

- TX INHIBIT: Transmission is disabled.
- RX MUTE: Audio output is disabled.
- BOTH: Both transmission and audio output are disabled.

### ◇ Remote exchange “REM SWAP”

Sets the remote control (p. 15) to use the frequency exchange key or not.

- OFF: The remote control for the frequency exchange key is OFF.
- ON: The remote control for the frequency exchange key is ON.

### ◇ Remote incom “REM INCOM”

Sets the remote control (p. 15) to use the intercom or not.

- OFF: The remote control for the intercom is OFF.
- ON: The remote control for the intercom is ON.

### ◇ Remote recall “REM RECALL”

Sets the remote control (p. 15) to use the recall key or not.

- OFF: The remote control for the recall key is OFF.
- ON: The remote control for the recall key is ON.

### ◇ Memory clear “MEM CLEAR”

Selects an item to be reset.

After the selection, hold down [MEM] for two seconds to reset the selected item’s contents.

- MENU: Reset the menu mode items setting to their defaults.
- MEMORY: Clear the stored memories except the weather memory channel.
- ALL: Reset the menu mode items setting to their defaults and clear the stored memories.

In Canada, use of 8.33 kHz Channel Spacing of this radio is strictly prohibited and shall not be used.

### ◇ General

- Frequency range:
  - Channel spacing: 25 kHz 118.000 to 136.975 MHz
  - Channel spacing: 8.33 kHz 118.000 to 136.992 MHz
  - Weather channel\* 161.650 to 163.275 MHz
- Channel spacing: 25 kHz or 8.33 kHz
- Frequency stability:  $\pm 5$  ppm ( $-20^{\circ}\text{C}$  to  $+55^{\circ}\text{C}$ ;  $-4^{\circ}\text{F}$  to  $+131^{\circ}\text{F}$ )
- Operating temperature:  $-20^{\circ}\text{C}$  to  $+55^{\circ}\text{C}$ ;  $-4^{\circ}\text{F}$  to  $+131^{\circ}\text{F}$
- Antenna impedance: 50  $\Omega$
- Number of memory channels:
  - 20 regular memory channels
  - 50 group memory channels
  - 20 history memory channels
  - 10 weather memory channels\*
- Mode:
  - AM 6K00A3E/5K60A3E
  - FM\* 16K0G3E
- Power supply requirement: 13.80 V/27.50 V DC (negative ground)
- Dimensions: 160 (W) $\times$ 34 (H) $\times$ 271 (D) mm; (projections not included) 6.3 (W) $\times$ 1.3 (H) $\times$ 10.7 (D) inches
- Weight (approximately): 1.2 kg; 2.645 lb

### ◇ Transmitter

- Classes: 4 and 6
- Output power:
  - More than 12 V DC: 8 W (Carrier power)
  - 10 V DC: 4 W (Carrier power)
 Transmit is locked out below 9 V DC.
- Spurious emissions:  $-60$  dBc
- Microphone impedance: 600  $\Omega$
- Modulation limiting: 70% (Maximum 98%)

### ◇ Receiver

- Classes: D and E
- Receive system: Double conversion superheterodyne
- Intermediate frequencies:
  - 1st 38.85 MHz
  - 2nd 450 kHz
- Sensitivity:
  - AM Less than 2  $\mu\text{V}$  (pd) at 6 dB S/N
  - FM\* Less than 1.4  $\mu\text{V}$  (pd) at 12 dB SINAD
- Selectivity (with 8.33 kHz channel spacing):
  - 6 dB  $\pm 2.778$  kHz
  - 60 dB  $\pm 7.37$  kHz
- Spurious response rejection: More than 74 dB $\mu$
- Audio output power:
  - External speaker 5 W into a 4  $\Omega$  load
  - Headphones 60 mW into a 500  $\Omega$  load

\*Receiving only.

**Measurements made in accordance with RTCA DO-186B.**



■ TSO Deviation list

TSO/ETSO	Deviation
TSO-C128a	1. Icom was granted a deviation from the TSO to mark the exterior of the unit with the serial number instead of the date of manufacture.
	2. Icom was granted a deviation from the TSO to use RTCA/DO-160G instead of the earlier version as the standard for environmental conditions and tests.
	3. Icom was granted a deviation from the TSO to use RTCA/DO-178C instead of the earlier version to demonstrate compliance for the verification and validation of computer software.
TSO-C169a	1. Icom was granted a deviation from the TSO to mark the exterior of the unit with the serial number instead of the date of manufacture.
	2. Icom was granted a deviation from the TSO to use RTCA/DO- 160G instead of the earlier version as the standard for environmental conditions and tests.
	3. Icom was granted a deviation from the TSO to use RTCA/DO-178C instead of the earlier version to demonstrate compliance for the verification and validation of computer software.

• FCC Grant of Equipment Authorization

Model	FCC ID	IC ID
IC-A220	AFJ297410	202D-297410

■ VFO channel ID list

• Channel spacing: 25 kHz (Actual frequency is displayed.)

Operating Frequency (MHz)	Channel spacing (kHz)	Channel ID (Displayed Frequency)
118.0000	25	118.000
118.0250	25	118.025
118.0500	25	118.050
118.0750	25	118.075
118.1000	25	118.100

• Channel spacing: 8.33 kHz

Operating Frequency (MHz)	Channel spacing (kHz)	Channel ID (Displayed Frequency)
118.0000	8.33	118.005
118.0083	8.33	118.010
118.0167	8.33	118.015
118.0250	8.33	118.030
118.0333	8.33	118.035
118.0417	8.33	118.040
118.0500	8.33	118.055
118.0583	8.33	118.060
118.0667	8.33	118.065
118.0750	8.33	118.080
118.0833	8.33	118.085
118.0917	8.33	118.090
118.1000	8.33	118.105

These tables show just the display example between 118.0000 MHz and 118.1000 MHz. Not show all frequencies in the band are shown.

---

## INDEX

A	
AM squelch level .....	19
Automatic noise limiter .....	19
Auto squelch .....	21
B	
Basic operation .....	4
Beep tone level .....	20
C	
Channel tag .....	11
Clearing the memory contents .....	9
Configuration menu .....	18
Configuration menu items .....	21
D	
Dimmer auto mode .....	22
Dimmer brightness .....	22
Dimmer mode .....	22
Dimmer response .....	23
Directly setting the frequency .....	6
Dualwatch .....	13
Dualwatch interval .....	21

E	
Emergency frequency .....	14
Enter frequencies into memory channels .....	9
Entering channel names .....	10
Entering group names .....	10
External dimmer control .....	22
External input .....	23
External input gain .....	23
External input level .....	20
F	
FM squelch level .....	19
Frequency display .....	20
Frequency step .....	15, 20
Front panel .....	1
Function display .....	3
G	
Group memory .....	8
H	
Headphones level .....	19
History memory channel .....	12

I

Intercom..... 14  
 Intercom 1 microphone audio input level..... 19  
 Intercom 1 squelch level..... 21  
 Intercom 2 microphone audio input level..... 19  
 Intercom 2 squelch level..... 21  
 Intercom usable setting ..... 23  
 Interlock ..... 24  
 Interlock mode ..... 24

M

Manual dimmer control ..... 20  
 Memory clear ..... 24  
 Memory operation..... 7  
 Memory protection..... 21

P

Priority watch ..... 13  
 Priority watch interval ..... 21  
 Protecting memory ..... 12

R

Receiving..... 5  
 Regular memory ..... 8  
 Remote control ..... 15  
 Remote exchange ..... 24  
 Remote incom ..... 24  
 Remote recall ..... 24

S

Setting menu items ..... 19  
 Setting microphone 1 Gain ..... 20  
 Setting microphone 2 Gain ..... 20  
 Settings menu..... 17  
 Sidetone level..... 20  
 Squelch for test..... 14  
 Squelch mode..... 19

T

Time-Out-Timer ..... 24  
 Transmitting ..... 5  
 Transmitting microphone selection ..... 22  
 TSO deviation list ..... 26

U

USER-1 setting/USER-2 setting ..... 23

V

VFO channel ID list..... 26

W

Weather memory channel ..... 12

**Count on us!**

Printed in Japan  
© 2016 Icom Inc.  
Basic Issue: May 09/16

Revision 2: Jul 06/16

Printed on recycled paper with soy ink.

**Icom America Inc.**  
12421 Willows Road NE, Kirkland, WA 98034, U.S.A