

NOTES:

1. EXISTING EQUIPMENT.
2. PERMISSIBLE TO TRIM PARTS CREATED BY THIS DRAWING ON INSTALLATION AS REQUIRED.
3. TOUCH UP ALL BARE ALUMINUM SURFACES WITH ALODINE PER MIL-C-5541 CLASS 3.
4. PARENTHETICAL ENTITIES, ( ), ARE FOR REFERENCE ONLY.
5. LOCATE CIRCUIT BREAKER IN THE SAME GENERAL AREA WITH EXISTING CIRCUIT BREAKERS. LABEL AS SHOWN USING STANDARD ENGRAVING, SILKSCREEN, OR OTHER TECHNIQUES. LETTERING TO BE SAME HEIGHT AS EXISTING C/B LETTERING.
6. \_\_\_\_\_ DENOTES EXISTING WIRES.
7. ALL GROUNDS GO TO NEAREST GROUND POINT ON AIRCRAFT.
8. TIE INTO EXISTING BUS BAR NEAR LOCATION OF NEW CIRCUIT BREAKER. IF A JUMPER WIRE IS REQUIRED, USE 20 GAUGE MIL-W-22759/XX TYPE.
9. BEST COMMERCIAL EQUIVALENT MAY BE SUBSTITUTED FOR THIS PART.
10. THE INSTALLATION OF WIRING TO BE PERFORMED IN ACCORDANCE WITH AC 43.13-1B, 2A, ACCEPTABLE METHODS, TECHNIQUES, AND PRACTICES - AIRCRAFT ALTERATIONS, CHAPTER 11. ALL WIRE TO BE MIL-W-22759/16 OR EQUIVALENT.
11. LETTERING TO BE .10 HIGH MINIMUM, WHITE, HELVETICA, LOCATED APPROX AS SHOWN. USE STANDARD SILKSCREENING, ENGRAVING OR PLACARD TECHNIQUES.
12. OPTIONAL MOUNTING SCREW / MOUNTING HOLE.
13. SEE OWNERS MANUAL 01-2510-02 FOR INSTALLATION CRITERIA.
14. SEE MFG INSTALLATION MANUAL FOR RS-232 HOOKUPS (OPTIONAL).
15. THE FOLLOWING IS A GUIDE FOR UNSWITCHED AUDIO PINOUTS. PINOUTS MUST BE VERIFIED WITH LATEST MANUFACTURER DRAWINGS.

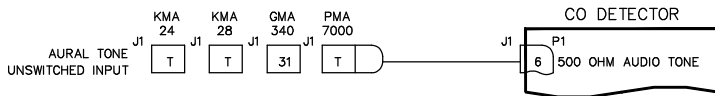

16. ACTIVATE VOICE SYNTHESIZED AUDIO PANELS ON PRODUCTS SUCH AS PS ENGINEERING MODEL PMA 7000B PIN 20.
17. OPTIONAL IF DETECTOR IS INSTALLED AWAY FROM THE PILOTS REACH OR INSTALLED IN A REMOTE APPLICATION.
18. SPARE GROUND USED BY GARMIN 900 AND G1000. SEE GARMIN INSTALLATION MANUAL.
19. MFD CONTROLLED BY RS232 REMOTE TEST/RESET.
20. TEMP OUTPUT (0-5V) SEE MFG INSTALLATION MANUAL.
21. CO OUTPUT (0-5V) SEE MFG INSTALLATION MANUAL.
22. ITEMS ARE OPTIONAL IF MFG RS-232 HOOKUP IS USED FOR REMOTE RESET AND DISPLAY OF DATA.
23. CABIN PRESSURE (0-5V) SEE MANUFACTURERS INSTALLATION MANUAL.

REVISIONS			
REV	DESCRIPTION	DATE	APVD
A	MINOR DRAWING CHANGES.	08/02/02	J. W. G.
B	ADDED EXTERNAL CO ALARM LAMP.	10/22/02	J. W. G.
C	CHANGED P/N OF ITEM 1 IN PARTS LIST, SHT. 1. IS: 452, WAS: 452-101-004. MODIFIED NOMENCLATURE ON C O DETECTOR.	11/19/02	J. W. G.
D	VISUAL LAYOUT CHANGED, PIN OUT CHANGED	4/20/06	C.R.M.
E	INSTALL FOR TABS -009 THRU -010 ADDED.	5/17/06	C.R.M.
F	FLAG NOTES ADDED, SHEETS 4 AND 5 ADDED.	1/14/08	C.R.M.
G	SHEET 6 ADDED, SOME NOTE CHANGES.	1/27/07	C.R.M.

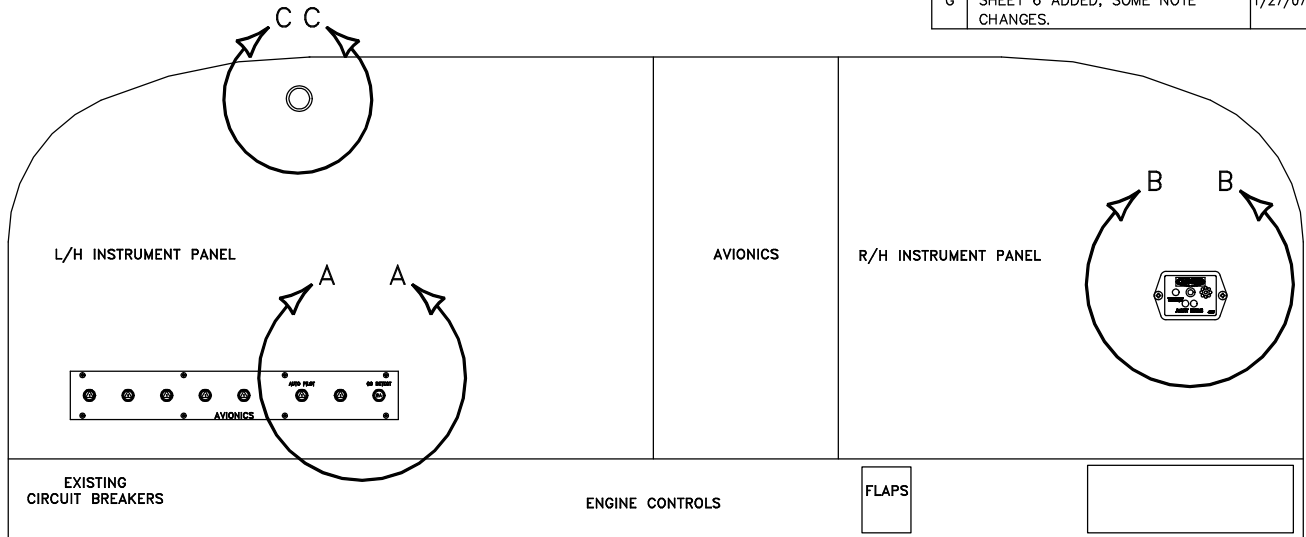

TYPICAL INSTRUMENT PANEL INSTALLATION

VIEW LOOKING FWD

9.	(5)	1	855SI-A-3-DDS	LAMP	SOLAN
	(4)	1	7277-2-2	CIRCUIT BREAKER	KLIXON
	(3)	1	TBD	CONNECTOR	
	(2)	1	TBD	CONNECTOR	
	(1)	1	452	C O DETECTOR	C O GUARDIAN

PROPRIETARY NOTICE		RIVET CODES PER NAS823 (B) = MS20426AD (B) = MS20470AD		APPROVALS		DATE	UNLESS OTHERWISE NOTED ALL DIM ARE IN INCHES		
This drawing contains specifications and/or data, technical material, proprietary designs and information that are the sole property of C O Guardian, LLC, and treated by its recipient as a confidential trade, and is not to be shown or disclosed to any unauthorized organization or person.		DESIGN		A.E.S.		09/12/01	TOLERANCES		
		DRAWN		ERIC WILSON		09/12/01	.XXX ±.010 ANGLES		
		CHECK		MIKE GORDON		09/12/01	.XX ±.03 ±1/2"		
		UNSP.					X		
UNLESS OTHERWISE NOTED: ALL BEND RAD TO BE 3 X MATL THICKNESS		DASH	NEXT ASSY	REL.	ASH VIJ	09/12/01	FINISH	NONE	
							SCALE	NONE	
								TITLE	CO DETECTOR INSTL.
								DRAWING NO.	01-2510-01
								SH 1 OF 7	REV G

FILENAME: 01-2510-01G

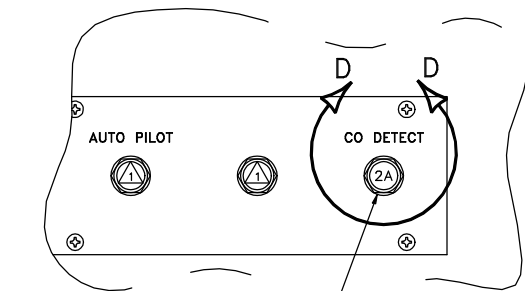

△(P/N 7277-2-2) CIRCUIT BREAKER

SECTION A-A

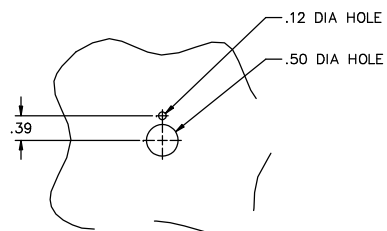

SECTION D-D  
C/B REMOVED FOR CLARITY

(855SI-A-3-DDS LAMP)  
.375 DIA. MOUNTING HOLE  
LOCATE APPROX AS SHOWN

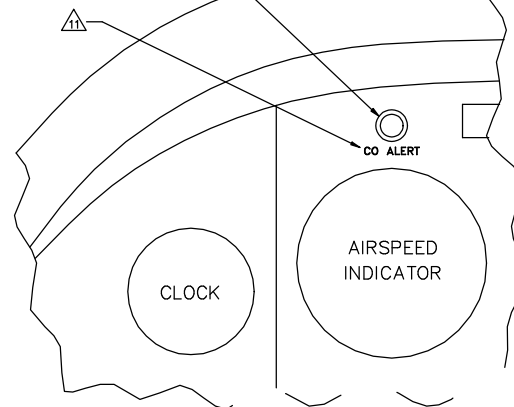

SECTION C-C

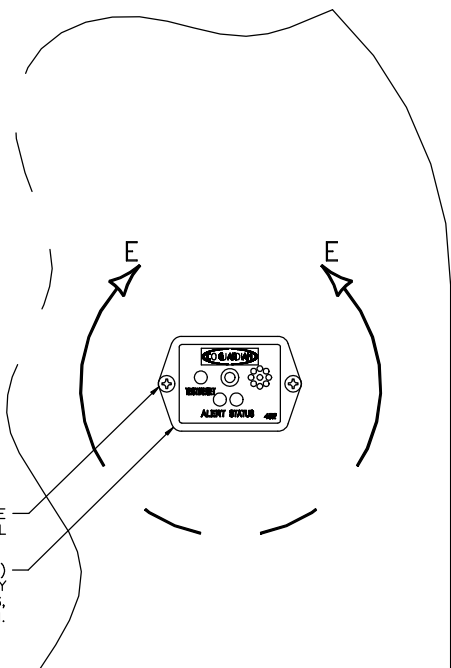

SECTION B-B

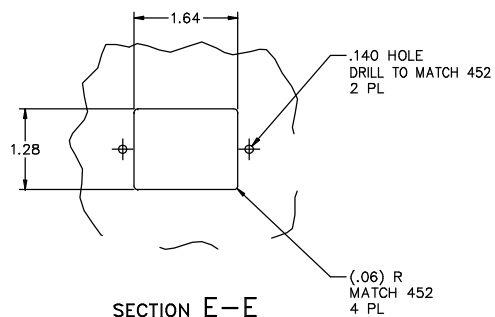

SECTION E-E  
452 REMOVED FOR CLARITY

NOTE:

OPTIONAL FLUSH MOUNT INSTALLATION: MOUNT 452 CO DETECTOR BEHIND MOUNTING HOLE IN INSTRUMENT PANEL.

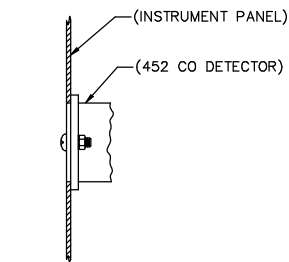
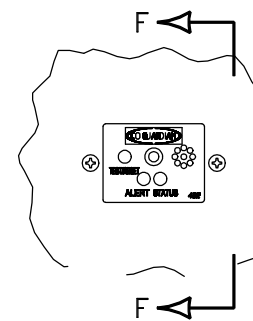

SECTION F-F

**CO GUARDIAN** 1861 East Airport Drive  
Tucson, AZ 85708

TITLE  
CO DETECTOR INSTL.

DRAWING NO. 01-2510-01 SH 2 OF 7 REV 2 OF 7 G

FILENAME: 01-2510-01G

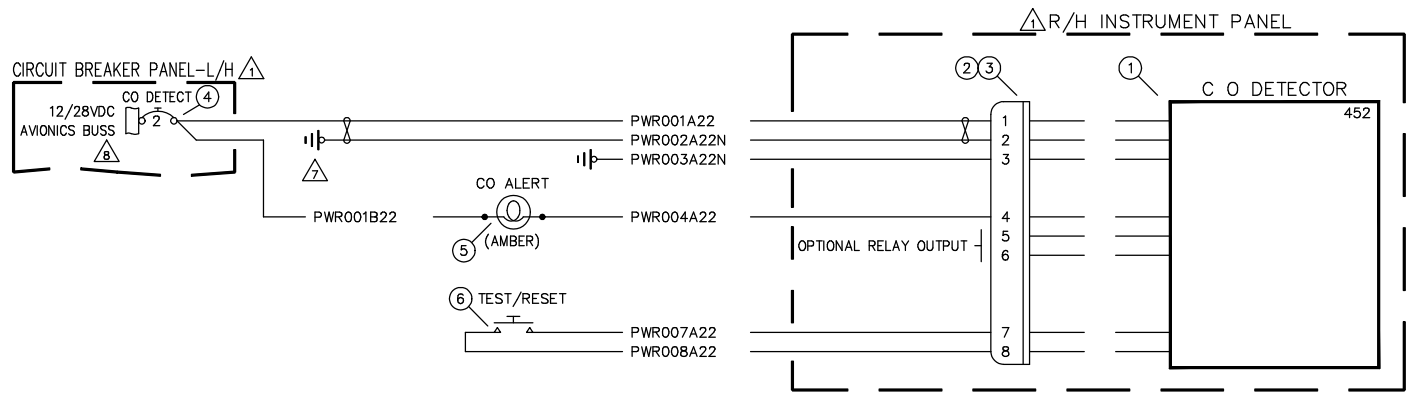

C O DETECTOR INSTALLATION WIRING DIAGRAM

452-101-001 THRU -004 INSTL

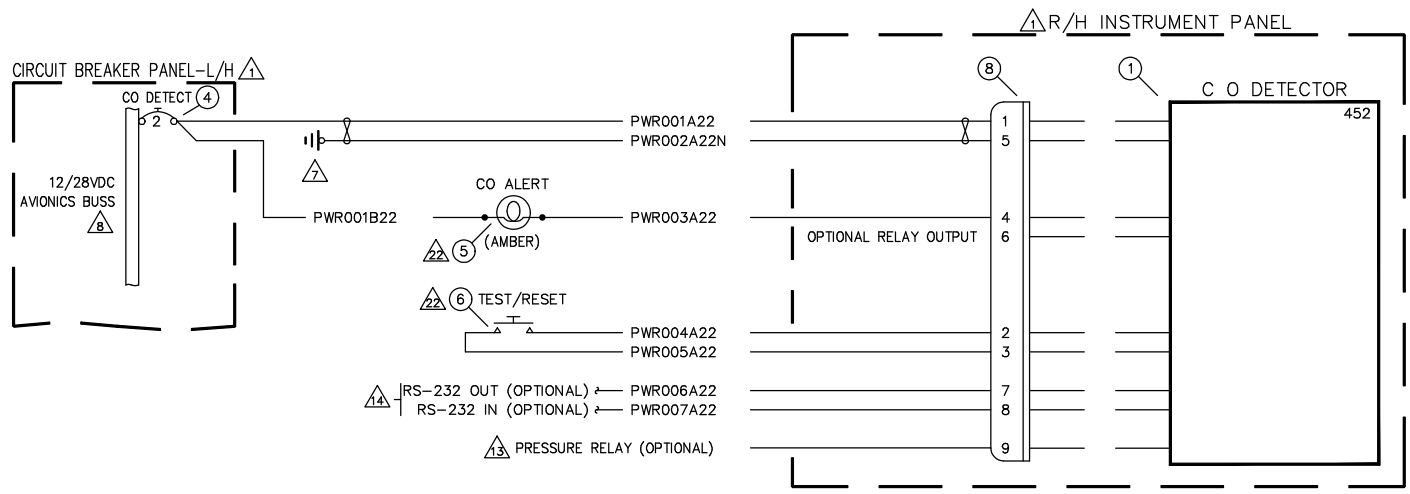

C O DETECTOR INSTALLATION WIRING DIAGRAM

452-101-005 THRU -009 INSTL

<b>CO GUARDIAN</b>		1851 Elm Airport Drive Tucson, AZ 85706	
TITLE CO DETECTOR INSTL.			
DRAWING NO. 01-2510-01	SH 3	REV 7	G

CIRCUIT BREAKER PANEL

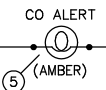
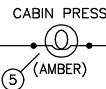
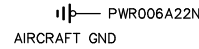
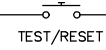
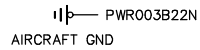
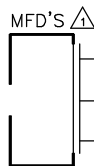
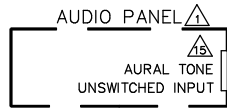
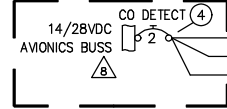

PWR001A22

PWR003A22

PWR006A22N

PWR001C22

PWR007A22

PWR001E22

PWR001A22

PWR010A22

PWR009A22

①②③

CO DETECTOR

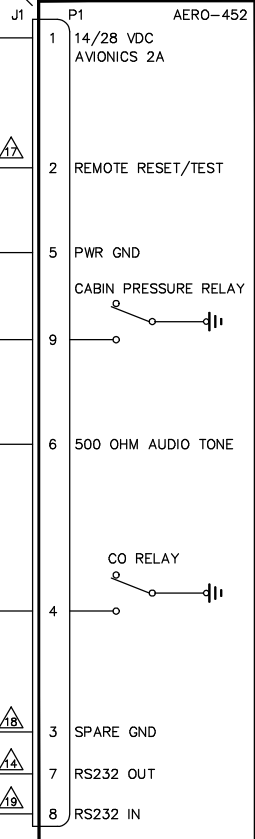

C O DETECTOR INSTALLATION WIRING DIAGRAM

452-101-010

		1861 East Airport Drive Tucson, AZ 85706	
TITLE			
CO DETECTOR INSTL.			
DRAWING NO.		SH	
01-2510-01		4	
		REV	
		7 G	

FILENAME: 01-2510-01G

CIRCUIT BREAKER PANEL

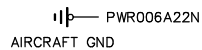
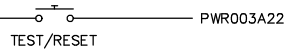
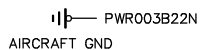
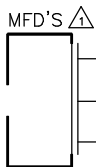
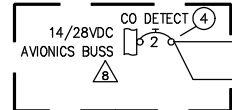

PWR001D22



PWR001E22

PWR001A22

PWR010A22

PWR009A22

① ② ③

CO DETECTOR

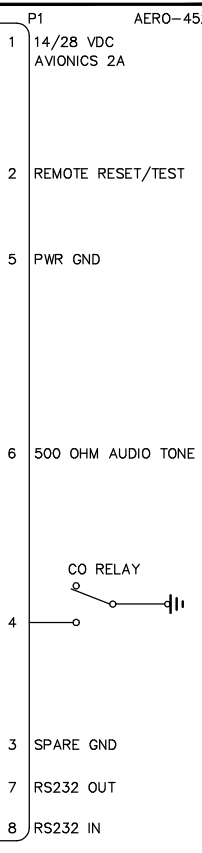

C O DETECTOR INSTALLATION WIRING DIAGRAM

452-101-011

		1881 East Airport Drive Tucson, AZ 85705	
TITLE			
CO DETECTOR INSTL.			
DRAWING NO.	SH	OF	REV
01-2510-01	5	7	G

FILENAME: 01-2510-01G

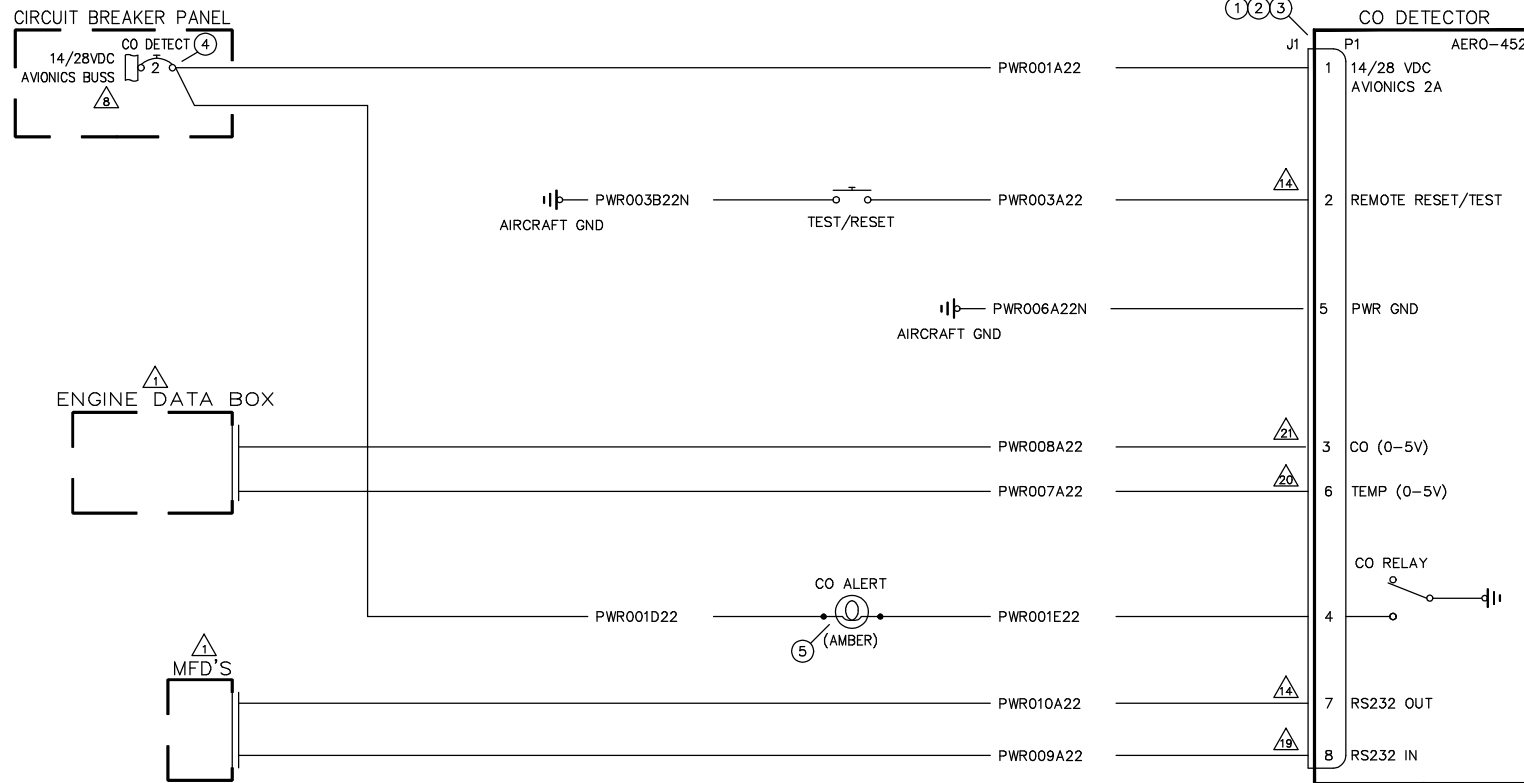

C O DETECTOR INSTALLATION WIRING DIAGRAM

452-101-012

		1881 East Airport Drive Tucson, AZ 85706
TITLE CO DETECTOR INSTL.		
DRAWING NO. 01-2510-01	SH OF 6 7	REV G

FILENAME: 01-2510-01G

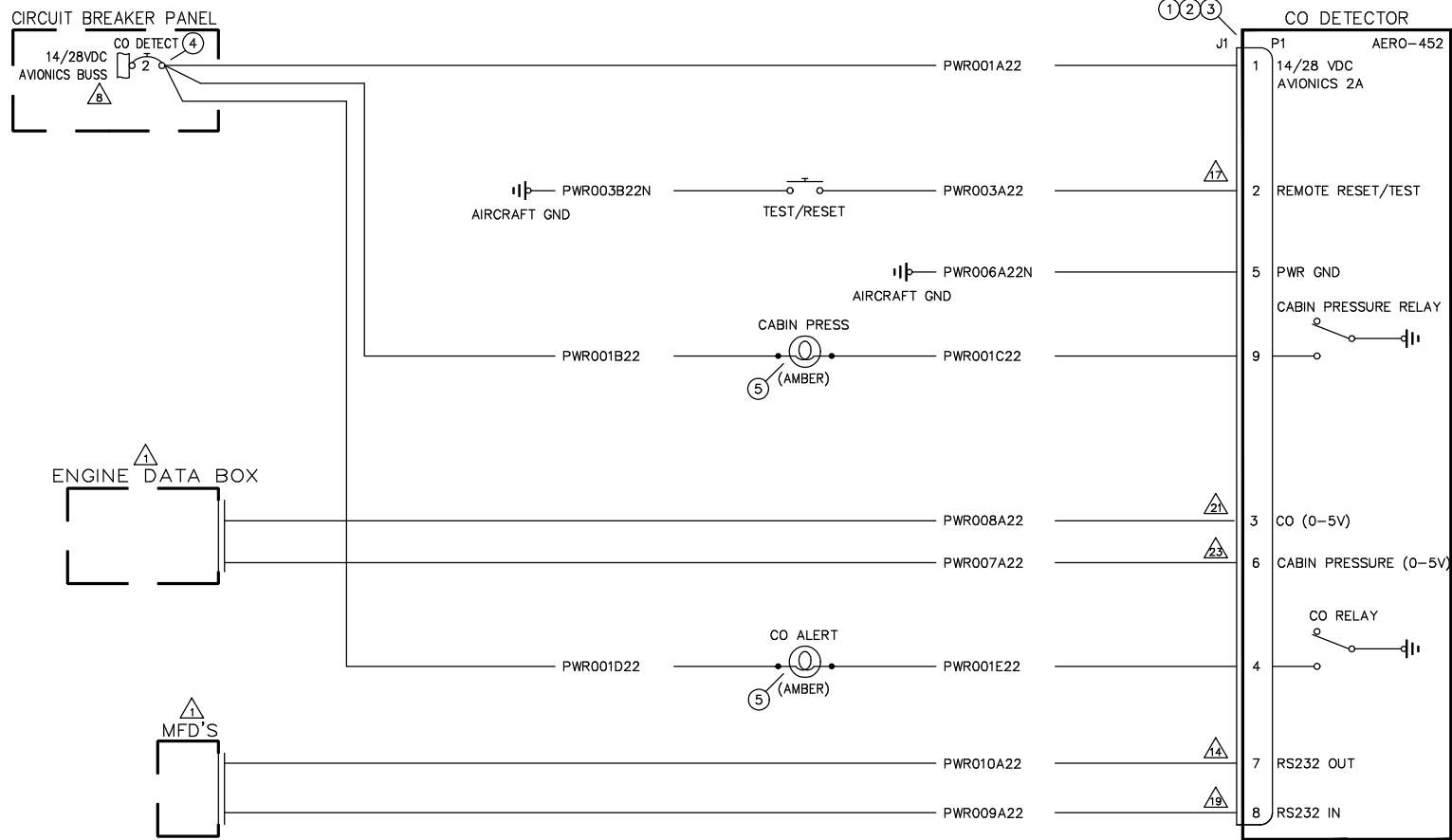

C O DETECTOR INSTALLATION WIRING DIAGRAM

452-101-013

<b>CO GUARDIAN</b>		1801 East Airport Drive Tucson, AZ 85706	
TITLE CO DETECTOR INSTL.			
DRAWING NO.	SH	REV	REV
01-2510-01	7	7	G
OF	7		

FILENAME: 01-2510-01G